

S2MF

2.0AMPS. GLASS PASSIVATED SURFACE MOUNT RECTIFIERS

FEATURE

- . High current capability
- . Low forward voltage drop
- . Low power loss, high efficiency
- . High temperature soldering guaranteed:
260°C/10 seconds at terminals.
- . For surface mounted application
- . Easy pick and place

MECHANICAL DATA

- . Case: Molded plastic
- . Epoxy: UL94V-0 rate flame retardant
- . Lead: MIL-STD- 202E, Method 208 guaranteed
- . Polarity:Color band denotes cathode end
- . Packaging:12mm tape per EIA STD RS-481
- . Mounting position: Any

SMF

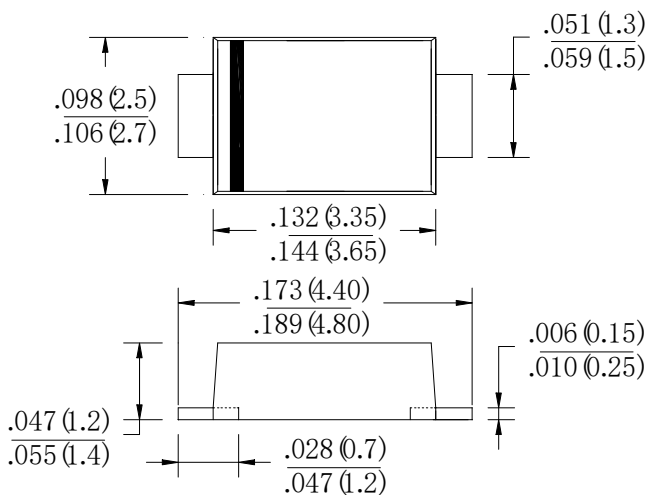

Dimensions in inches and (millimeters)

MAXIMUM RATINGS AND ELECTRICAL CHARACTERISTICS

Ratings at 25°C ambient temperature unless otherwise specified.

Single phase, half wave, 60Hz,resistive or inductive load. For capacitive load, derate current by 20%

Type Number	SYM BOL	S2MF	units
Maximum Recurrent Peak Reverse Voltage	V_{RRM}	1000	V
Maximum RMS Voltage	V_{RMS}	700	V
Maximum DC blocking Voltage	V_{DC}	1000	V
Maximum Average Forward Rectified Current	$I_{F(AV)}$	2.0	A
Peak Forward Surge Current 8.3ms single half sine-wave superimposed on rated load (JEDEC method)	I_{FSM}	60.0	A
Maximum Forward Voltage at 2.0A DC	V_F	1.1	V
Maximum DC Reverse Current @ $T_J=25^\circ\text{C}$ at rated DC blocking voltage @ $T_J=125^\circ\text{C}$	I_R	5.0	μA
		200.0	
I^2t Rating for Fusing ($t < 8.3\text{ms}$)	I^2t	14.94	A^2Sec
Typical Junction Capacitance (Note1)	C_j	10	pF
Typical Thermal Resistance (Note 2)	$R_{(JA)}$	80	$^\circ\text{C} / \text{W}$
	$R_{(JC)}$	28	
Storage Temperature	T_{STG}	-55 to +150	$^\circ\text{C}$
Operation Junction Temperature	T_J	-55 to +150	$^\circ\text{C}$

Note:

1. Measured at 1.0 MHz and applied reverse voltage of 4.0Vdc
2. Measured on P.C.Board with $0.2 \times 0.2''$ ($5.0 \times 5.0\text{mm}$) Copper Pad Areas.

RATING AND CHARACTERISTIC CURVES

FIG.1-TYPICAL FORWARD CURRENT DERATING CURVE

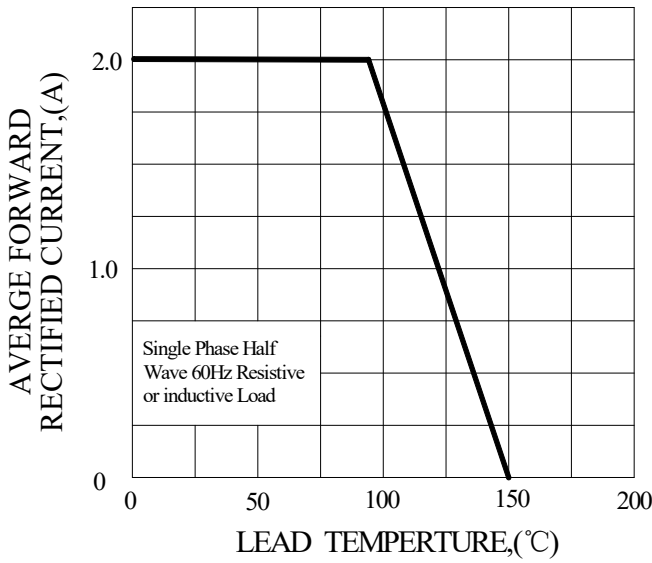

FIG.2-TYPICAL INSTANTANEOUS FORWARD CHARACTERISTICS

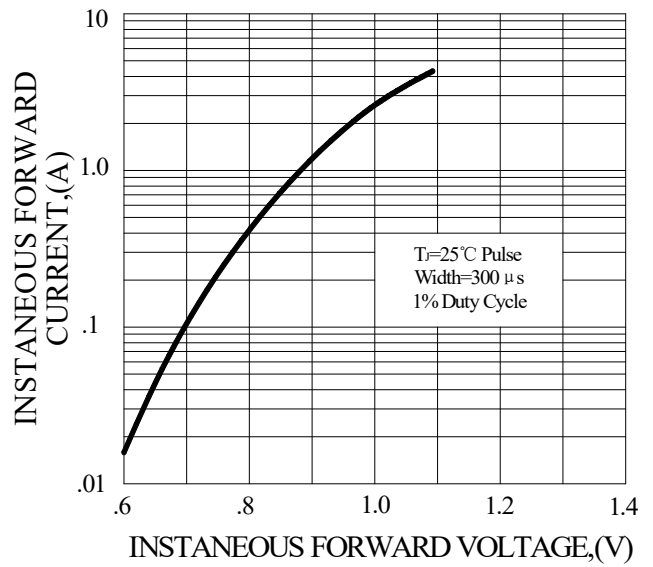

FIG.3-MAXIMUM NON-REPETITIVE FORWARD SURGE CURRENT

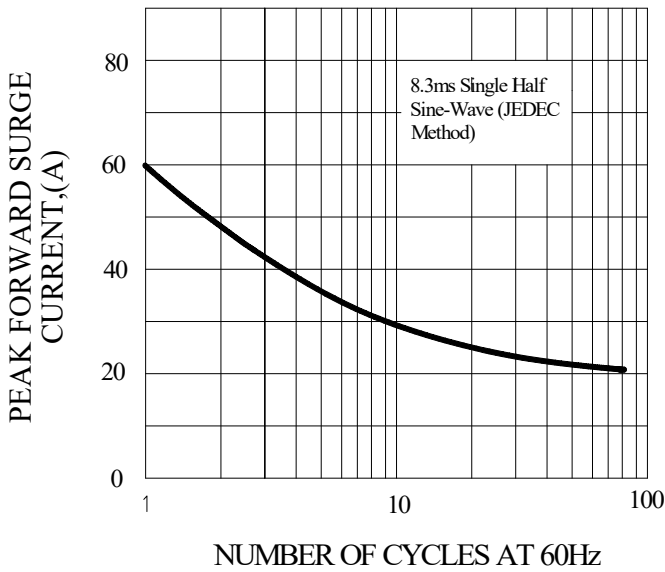
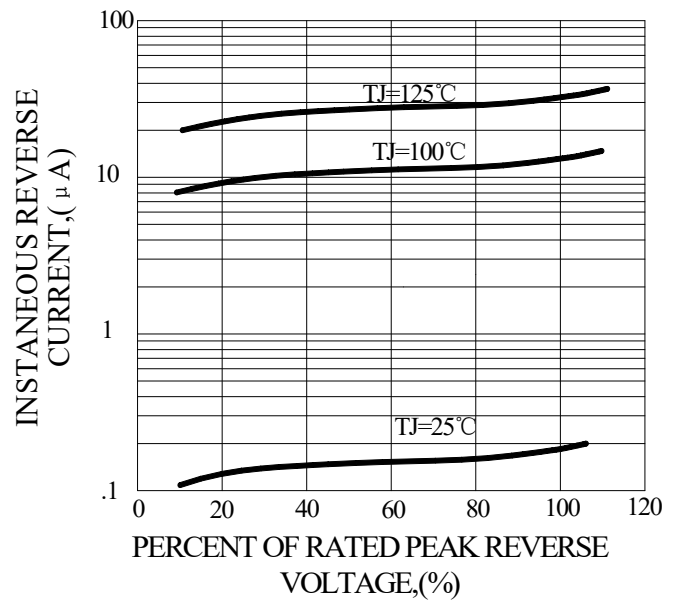
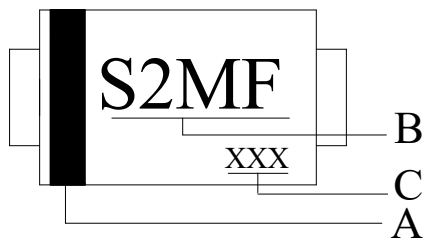

FIG.4 TYPICAL REVERSE CHARACTERISTICS



Marking and packaging illustration

1、Marking



SYMBOL	Explanation
A	Color Band Denotes Cathode
B	Product Name
C	Date Code

2、Packaging

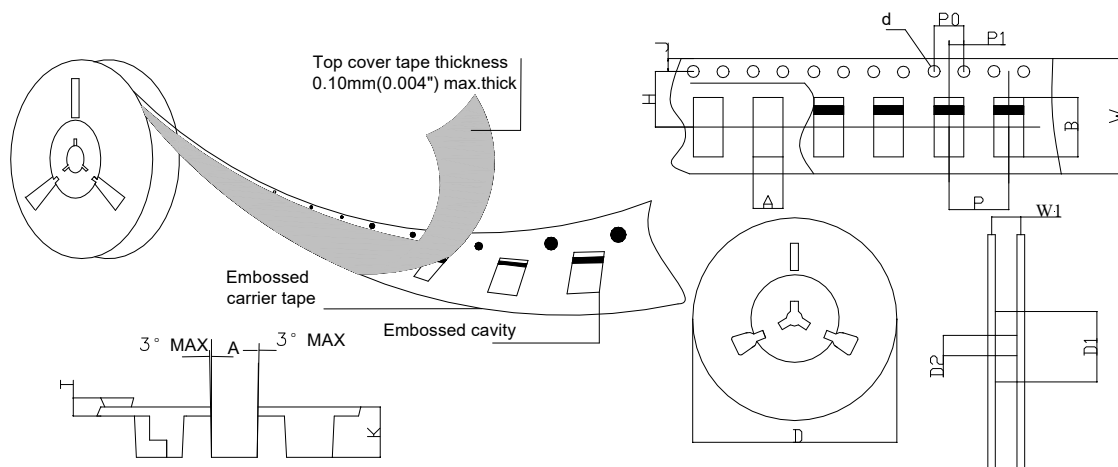

SPECIFICATIONS mm(inch)		PACKAGE
SYMBOL		SMF
ITEM		
Carrier width	A	2.93(0.115)Max
Carrier length	B	4.85(0.191)Max
Sprocket hole	d	ø1.55(0.061)Typ
Reel outer diameter	D	330.0(13.0)Typ
Reel inner diameter	D1	50.0(1.969)Min
Feed hole diameter	D2	13.0(0.512)Typ
Sprocket hole position	J	1.75(0.069)Typ
Punch hole position	H	5.50(0.217)Typ
Carrier depth	K	1.42(0.056)Typ
Punch hole pitch	P	4.00(0.157)Typ
Sprocket hole pitch	P0	4.00(0.157)Typ
Embossment center	P1	2.00(0.079)Typ
Overall tape thickness	T	0.25(0.010)Typ
Tape width	W	12.0(0.472)Typ
Reel width	W1	12.4(0.488)Min